

# Puzzle Sounds

## KATANA BOOSTER



# **KATANA BOOSTER**

**We hope you enjoy your new KATANA BOOSTER! In this manual, you will find documentation and guidelines helpful to put it together.**

Here we have put together a few links that detail some of the aspects explained in this manual and that we think you can find helpful:

[Kit & PuzzleKit general manual](#)

[Reading resistor and capacitor values](#)

Also, in our blog you can find multiple articles regarding tips for soldering, more in-depth posts about resistors and capacitors...

[Check it out!](#)

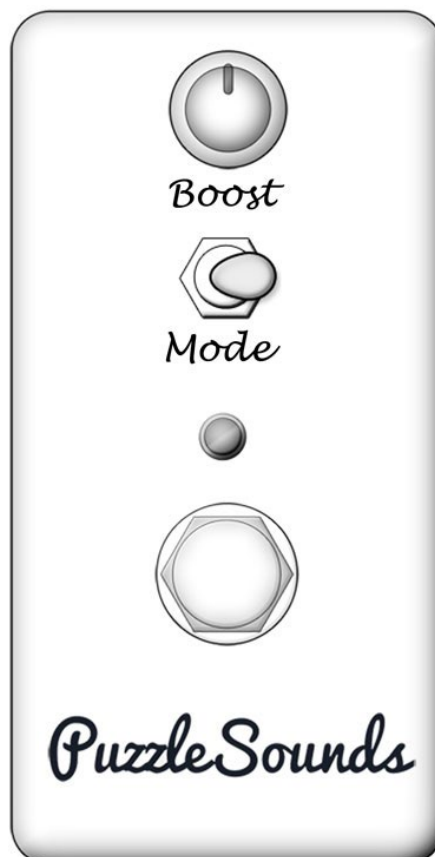

# **KATANA BOOSTER**

## **Bill Of Materials**

### **Resistors (7)**

3	R1, R4, R7	1M	
2	R2, R6	4.7k	
2	R3, R5	680	

### **Capacitors (9)**

1	C1	100p	(ceramic)
3	C2, C4, C5	220n	
3	C3, C8, C9	10u	(electrolytic)
1	C6	15n	
1	C7	1n	

### **Transistors (2)**

2	Q1, Q2	J113
---	--------	------

### **Diodes (2)**

2	D1, D2	1N60
---	--------	------

### **ICs (1)**

1	U1	MAX1044 / ICL7660s
---	----	--------------------

### **Potentiometers & Switches (2)**

1	VOL	250kB (lin.)
1	SW1 & SW2	DPDT Switch

### **Other (2)**

1	DP	1N4007	
1	RON	1k	

# KATANA BOOSTER

## Part Placement

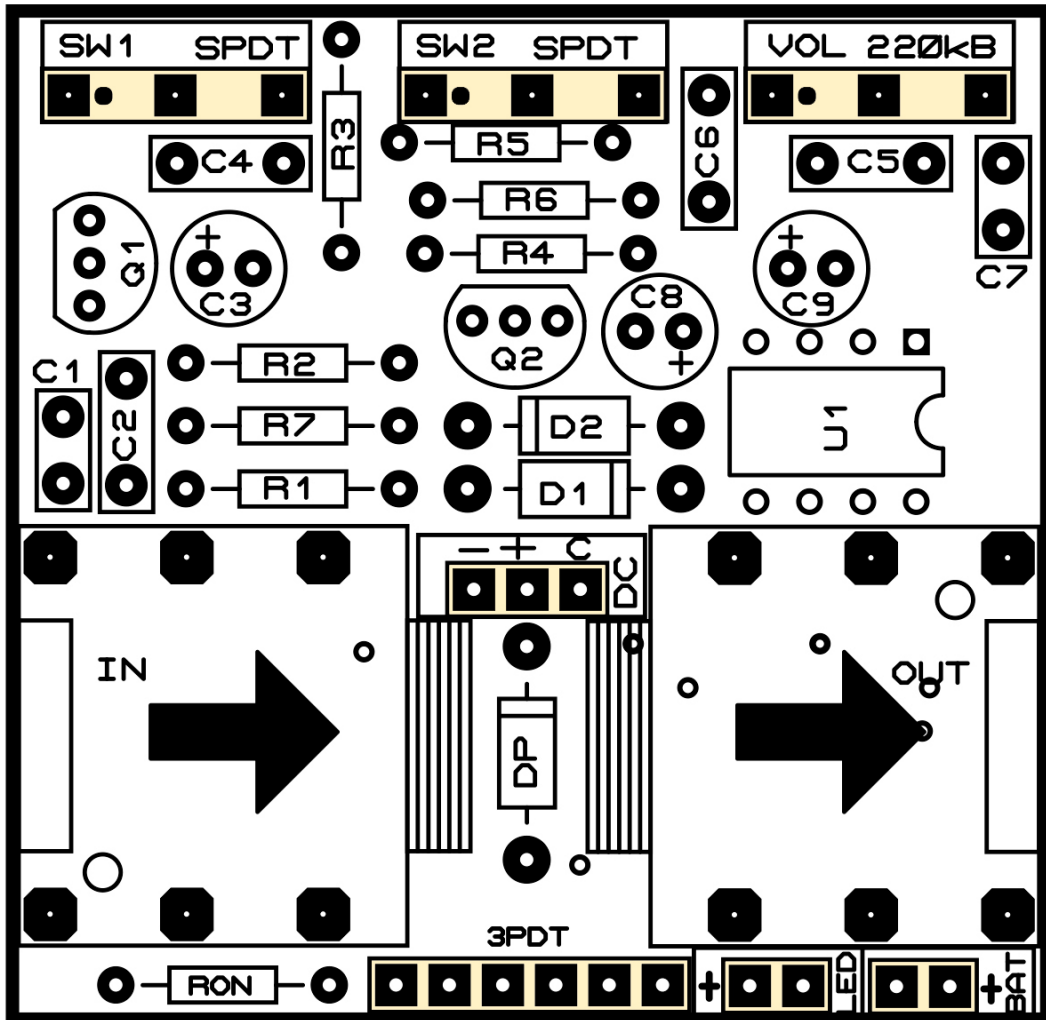

# KATANA BOOSTER

## STEP BY STEP GUIDE







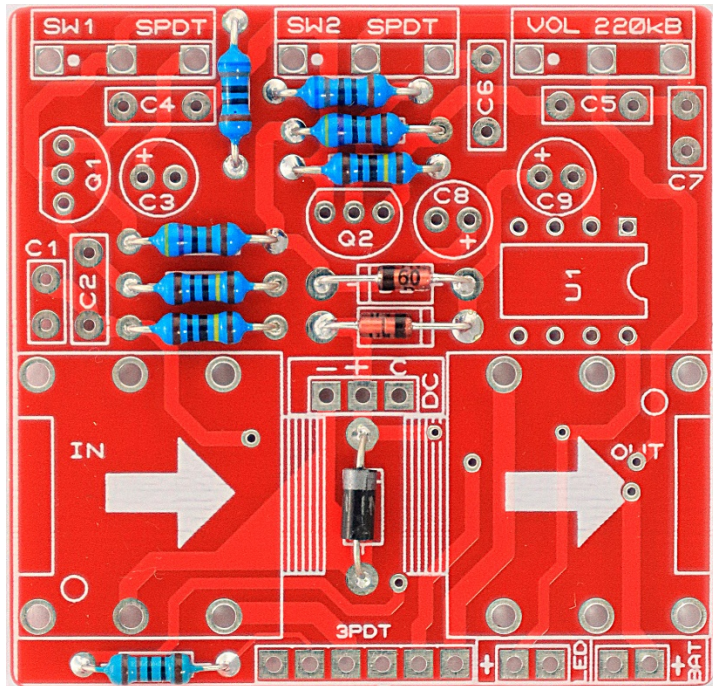







## STEP 1 - Resistors and diodes

Place the resistors and diodes. If you have troubles reading the values, check out our ["Reading Part Values"](#) tutorial.



### Resistors (31)

2	R1, R3	1M	
4	R2, R4, R10, R11	10k	
1	R5	5.1k	
3	R6, R8, R9	20k	
2	R7, R28	100k	
2	R12, R13	4.7M	
5	R14, R18, R19, R23, R24	330	
3	R15, R21, R25	4.7k	
4	R16, R20, R22, R26	6.8k	
1	R17	7.5k	
1	R27	1k	
2	R29, R30	47k	
1	R31	47	

### Other (2)

1	DP	1N4007	
1	RON	1k	

## STEP 2 - IC sockets & Pin header

First of all place the IC sockets (without the ICs). Pay attention to the orientation! The small notch in the socket should be oriented as indicated in the PCB.

Then, connect the 6 pin header:

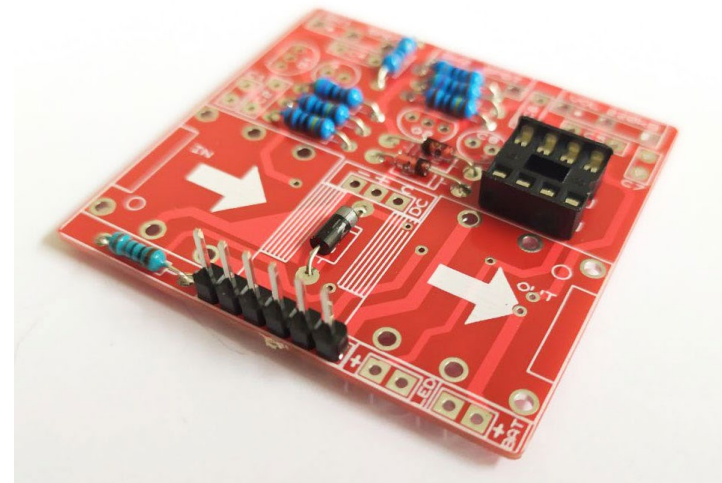
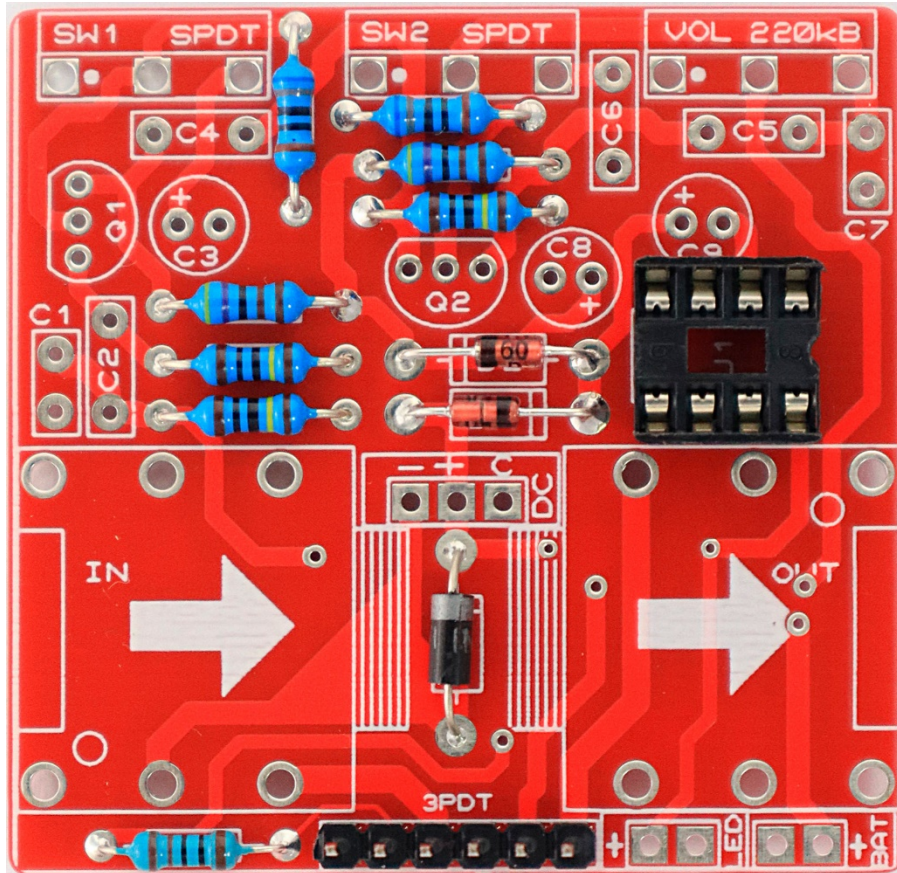

## STEP 3 - Capacitors and Transistors

Solder the capacitors and transistors. If you have troubles reading the values, check out our ["Reading Part Values"](#) tutorial. Pay attention to the orientation, as well as to the polarity for electrolytic capacitors.

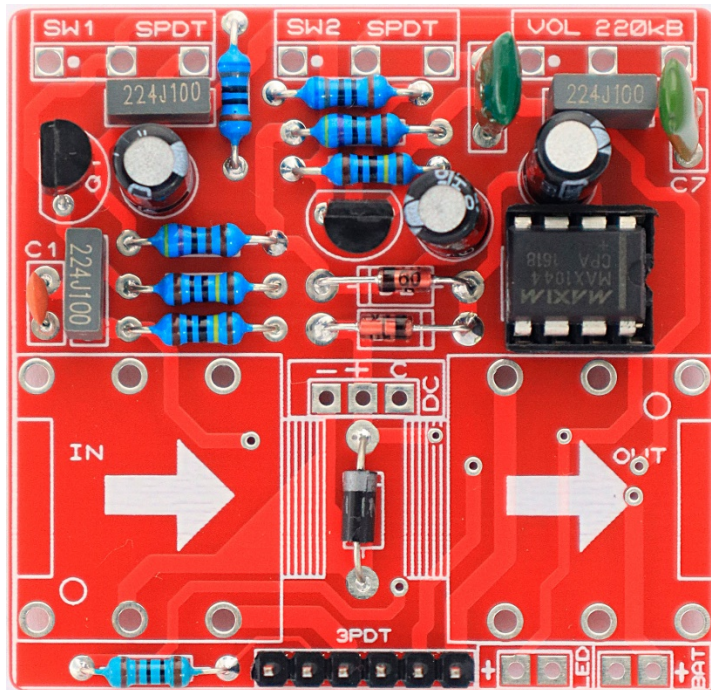

### Capacitor List

3	C1, C8, C9	22n
1	C2	220n
2	C3, C10	1u (electro.)
1	C4	68n
1	C5	8.2n
1	C6	2.2u (electro.)
2	C7, C11	100n
1	C12	100u (electro.)

### Transistor List

1	Q1	2N5457
2	Q2, Q3	BC550



## STEP 4 - LED and Battery Clip

Solder two wires to the LED connection (red to the “+” sign).

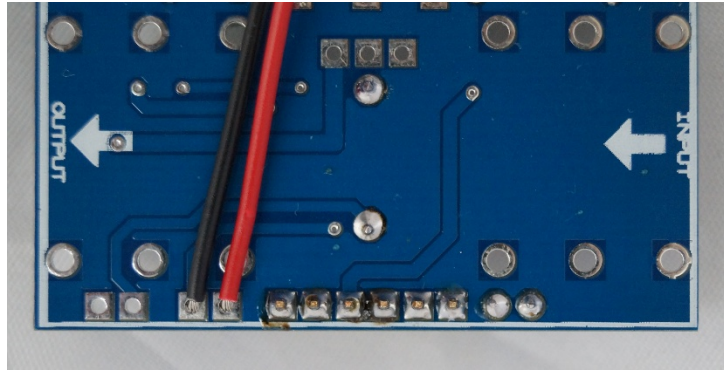

Then, solder them to the LED (the red wire is connected to the longer pin).

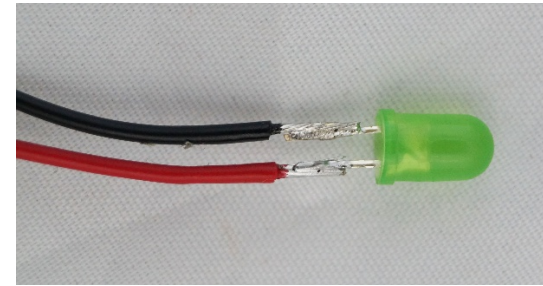

Solder the battery clip, connecting the red wire to the “+” sign:

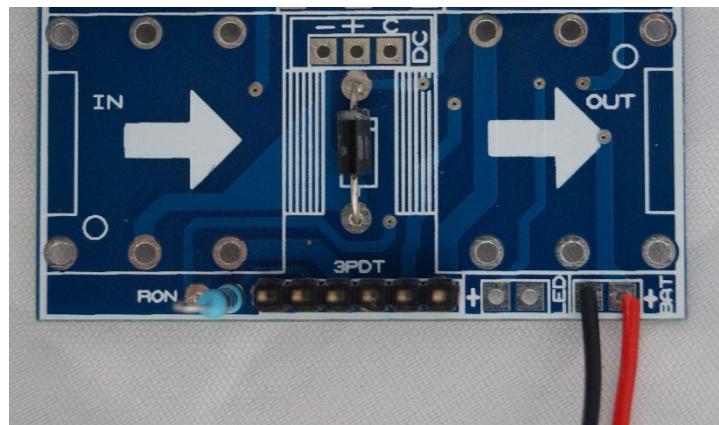

## STEP 5 - DC Power Jack wires

Solder three wires (about 5cm each) to the DC connection as shown (don't solder anything to the other end yet!):

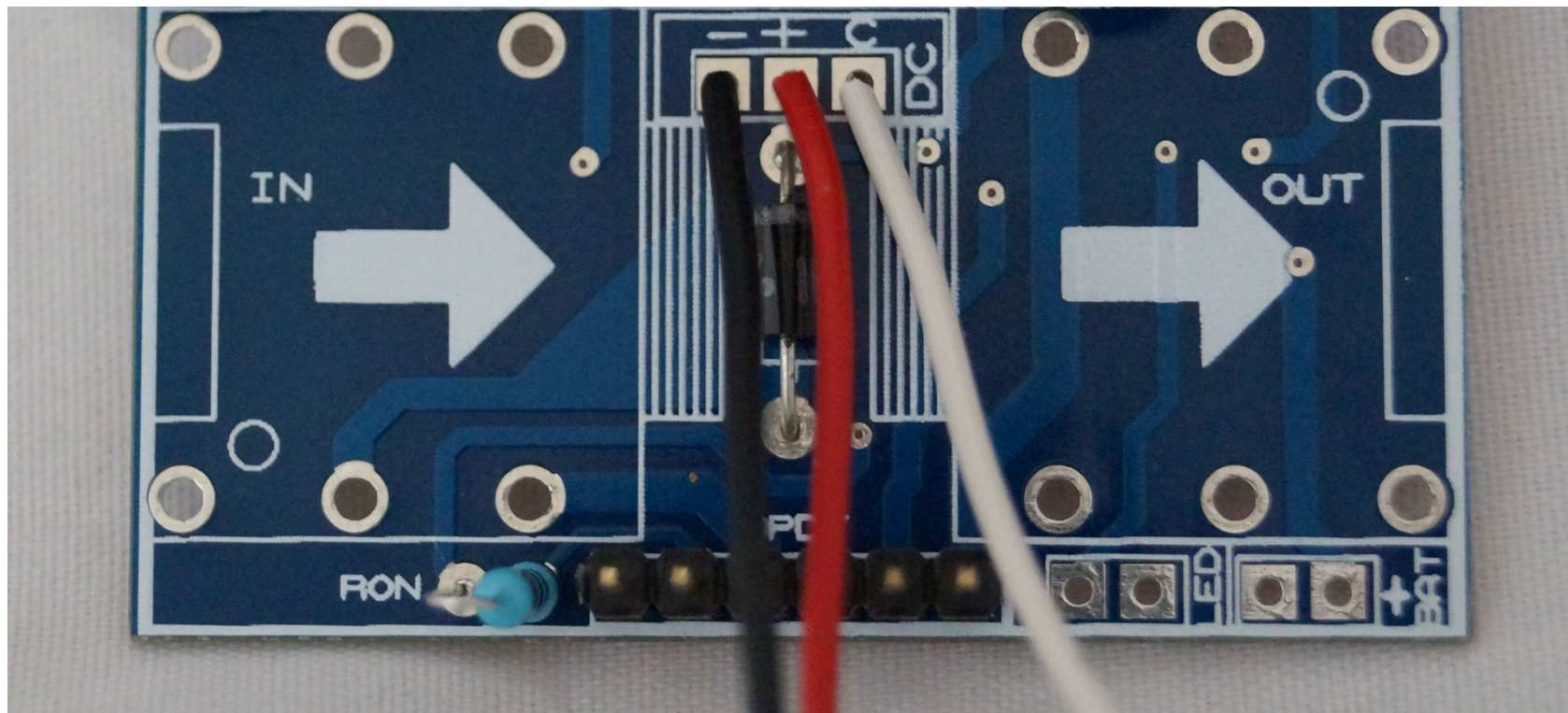

## STEP 6 - Audio Jacks

Now, solder the audio jacks to the board (DC, battery and led wires are not present to make it clearer):

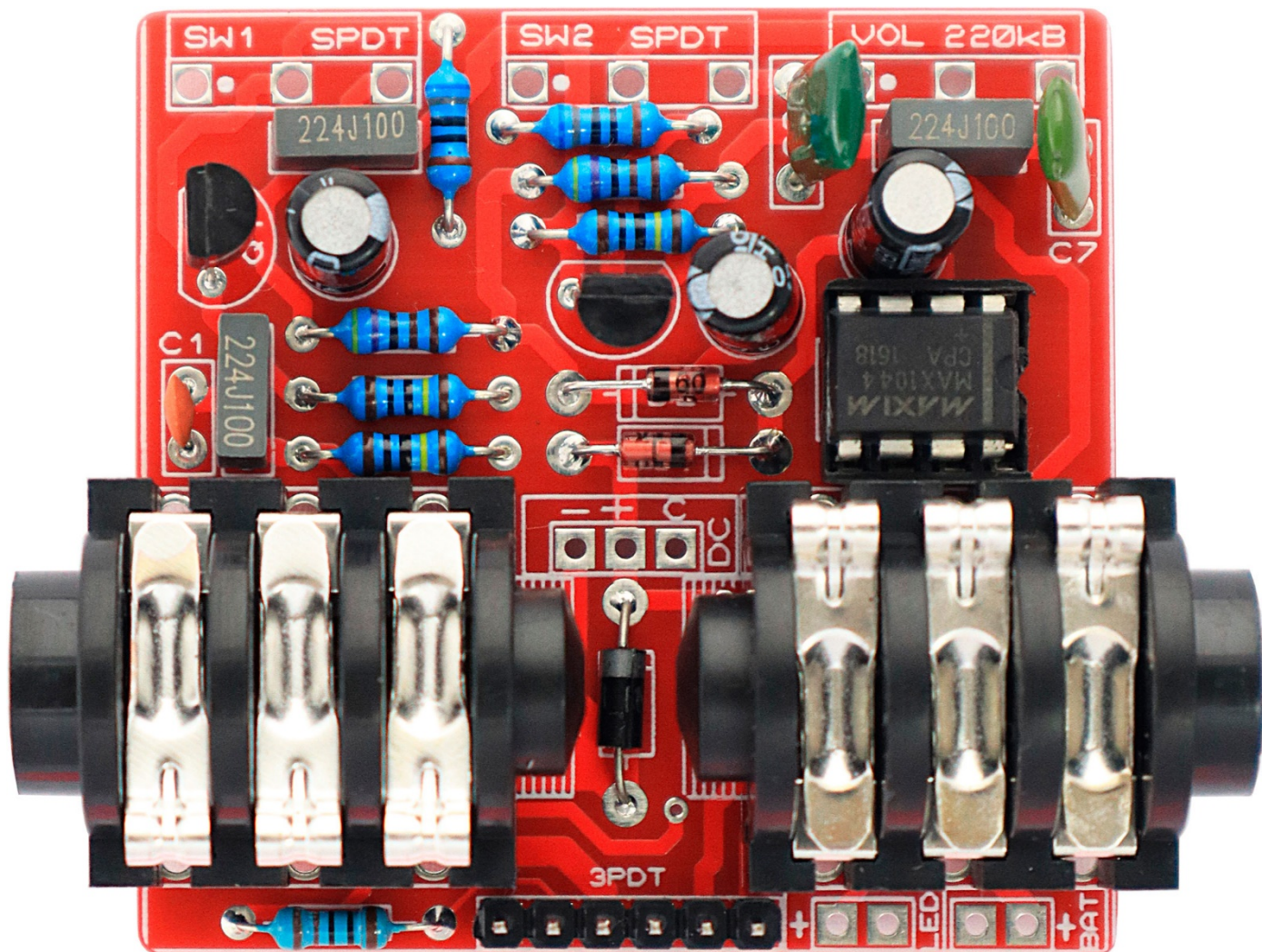

## **STEP 7 – Potentiometers**

### **A – Preparing the potentiometers**

Cut 3 pieces of wire for each potentiometer you have to solder (i.e. 9 pieces for 3 potentiometers). Then, solder them to each lug. The first lug is the one in the left in top view (the black wire in the picture).

Here, we've cut them short (~1cm), but you can use the length you need.

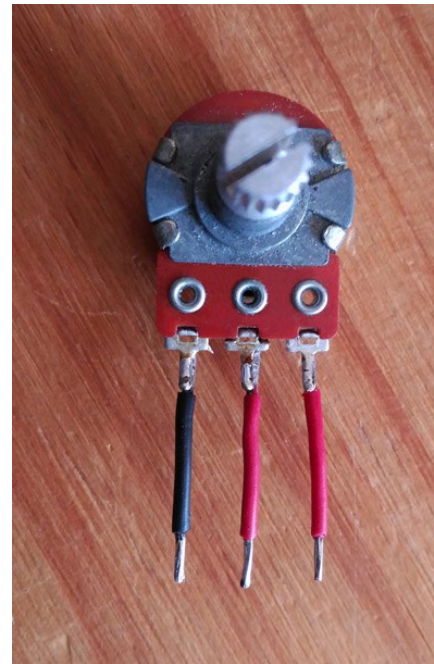

The pin 1 is shown in the PCB, either as a dot or as a "1" number (left picture). If your board doesn't specify a "1" or a dot, then the default 1 pins are being used. Below you can find the default pin 1 for our PCBs.

You can solder the potentiometers from above or from below (which we prefer) depending on how you plan to build the pedal.

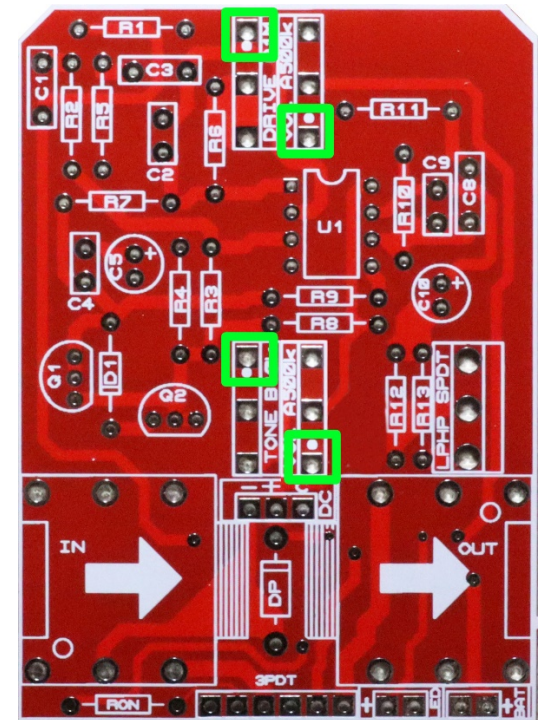
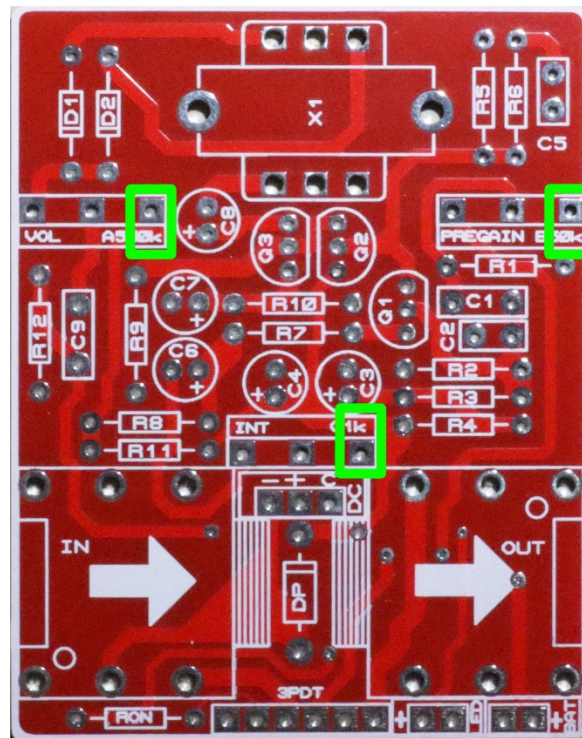
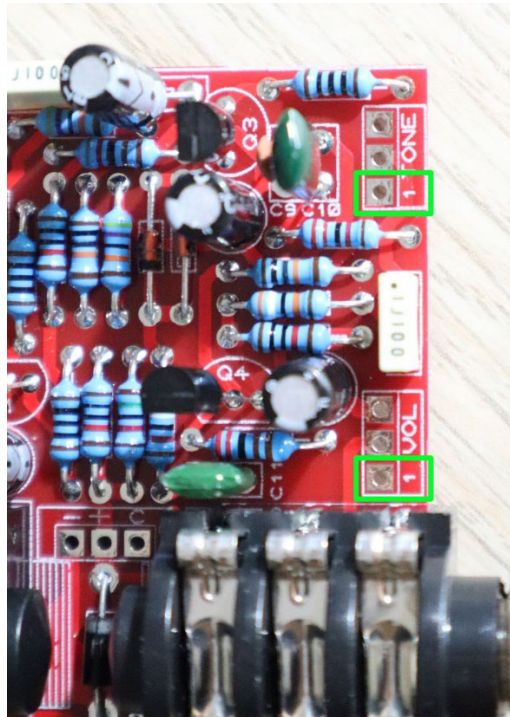

Then, solder them to the board like in the picture in the left, and then place the board inside the enclosure:

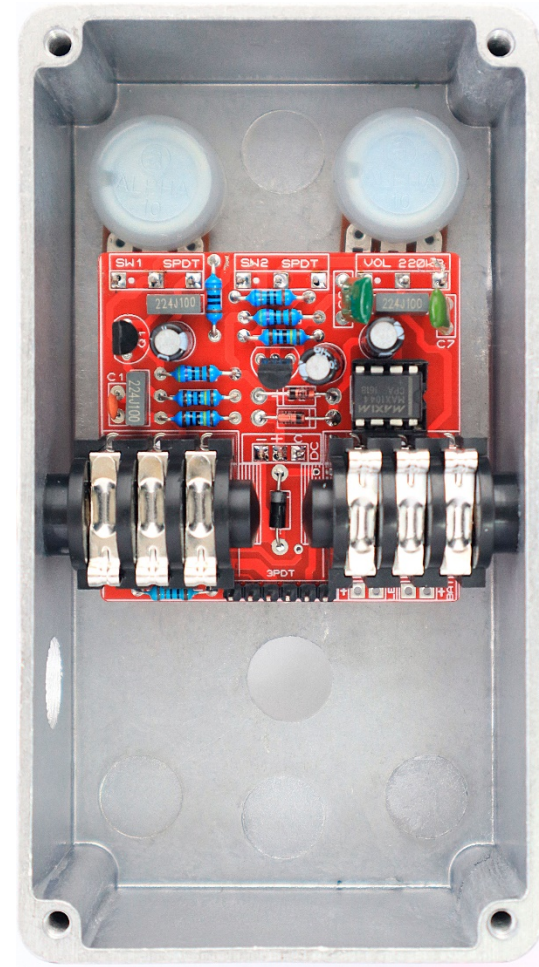
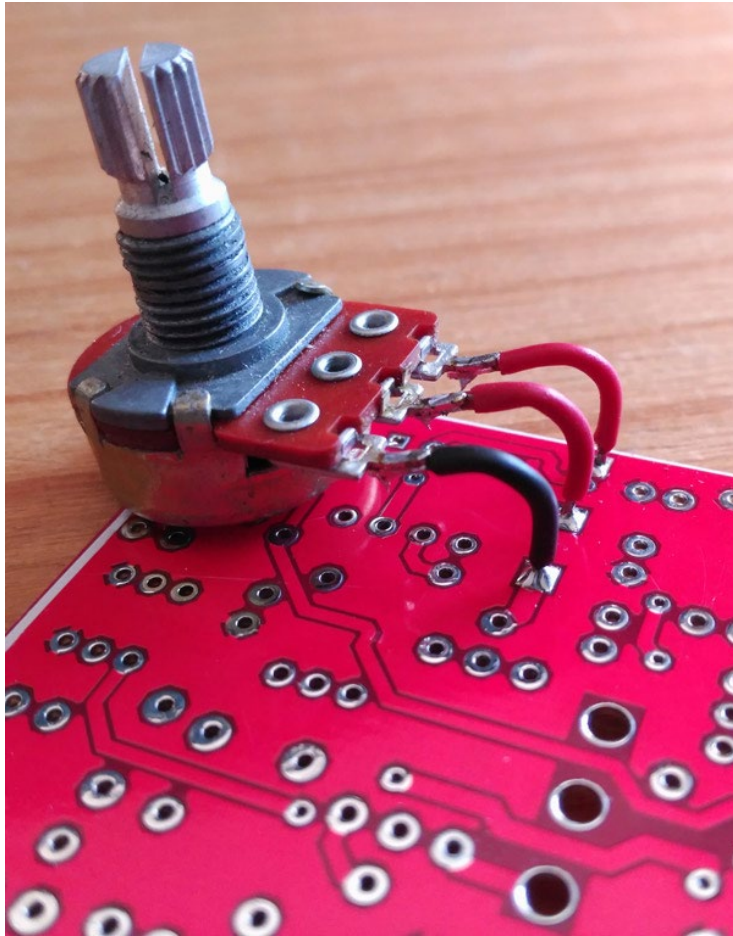

## **STEP 8 – DC Power Jack**

First of all, insert the DC jack in the enclosure and tighten the nut:



Then, solder the three wires from the DC connector in the board to the DC jack as follows:

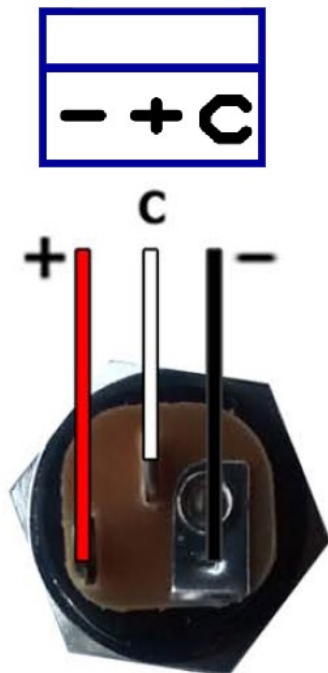

## **STEP 9 - 3PDT**

### **A - Solder the pin to the adapter**

Pay attention, the pins and the 3PDT must be soldered to the same side of the PCB adapter (the one labeled "buttons and 3PDT on this side").

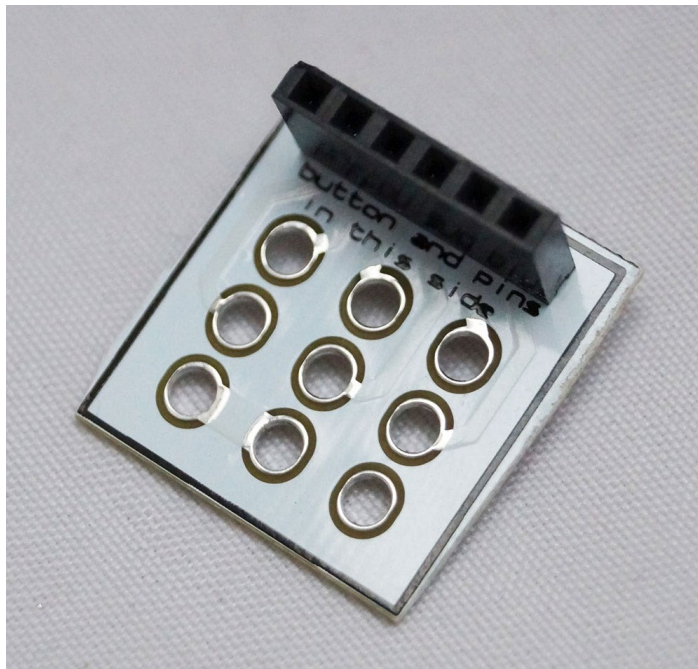

### **B - Solder the 3PDT**

Now solder the 3PDT to the PCB and remove all the nuts but one, that should be set at a middle height:





## C – Solder the 3PDT directly to the board (optional)

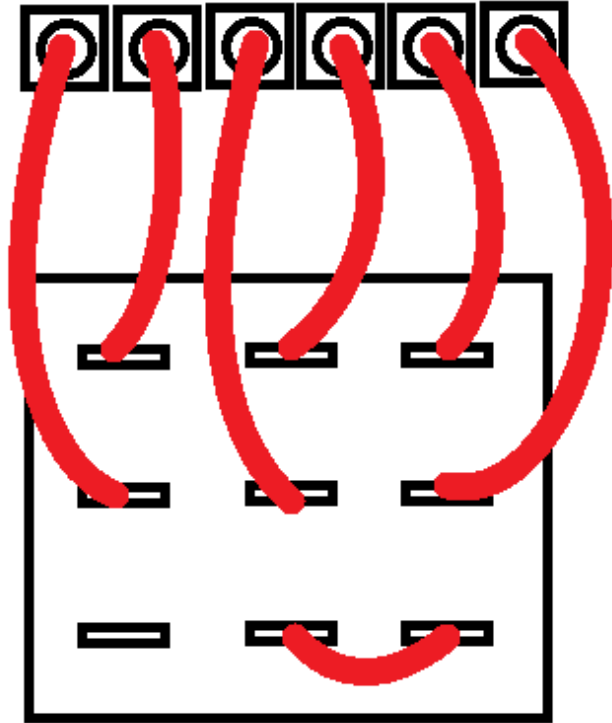

If you prefer to solder the 3PDT directly to the board, you can wire it as shown in the schematic. We recommend to use the **provided 3PDT PCB adapter** to make the soldering easier.

## **STEP 10 - Connect the 3PDT**

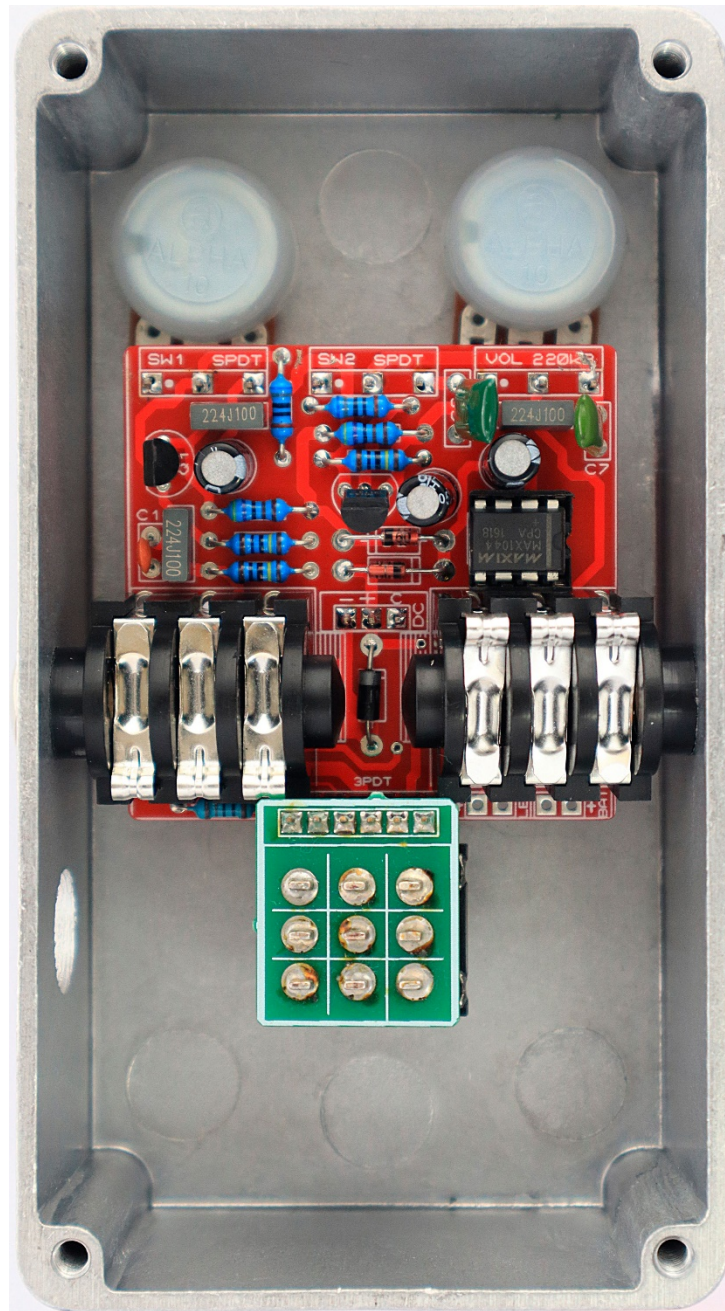

## **STEP 11 - Your pedal is finished!**

By now you should have a fully functional effect pedal, we hope you enjoy it!